

### STANDARD RECOVERY DIODES

Stud Version

#### Features

- High surge current capability
- Avalanche types available
- Stud cathode and stud anode version
- Wide current range
- Types up to 1200V  $V_{RRM}$

25 A

#### Typical Applications

- Battery charges
- Converters
- Power supplies
- Machine tool controls

#### Major Ratings and Characteristics

Parameters	25F(R)	Units
$I_{F(AV)}$	25	A
@ $T_C$	120	°C
$I_{F(RMS)}$	40	A
$I_{FSM}$ @ 50Hz	356	A
@ 60Hz	373	A
$I^2t$ @ 50Hz	636	A <sup>2</sup> s
@ 60Hz	580	A <sup>2</sup> s
$V_{RRM}$ range	100 to 1200	V
$T_J$ range	- 65 to 175	°C

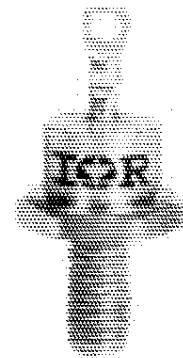

case style  
DO-203AA (DO-4)

**ELECTRICAL SPECIFICATIONS**

**Voltage Ratings**

Type number	Voltage Code	$V_{RRM}$ , maximum repetitive peak reverse voltage V	$V_{RSM}$ , maximum non-repetitive peak reverse voltage V	$V_{R(BR)}$ , minimum avalanche voltage V (1)	$I_{RRM}$ max. @ $T_J = 175^\circ\text{C}$ mA
25F(R)	10	100	150	--	12
	20	200	275	--	
	40	400	500	500	
	60	600	725	750	
	80	800	950	950	
	100	1000	1200	1150	
	120	1200	1400	1350	

(1) Avalanche version only available from  $V_{RRM}$  400V to 1200V.

**Forward Conduction**

Parameter	25F(R)	Units	Conditions
$I_{F(AV)}$ Max. average forward current @ Case temperature	25	A	180° conduction, half sine wave
	120	°C	
$I_{F(RMS)}$ Max. RMS forward current	40	A	DC @ $T_C = 25^\circ\text{C}$
$P_R$ Maximum non-repetitive peak reverse power	10	K/W	10µs square pulse, $T_J = T_J$ max. <b>see note (2)</b>
$I_{FSM}$ Max. peak, one-cycle forward, non-repetitive surge current	356	A	t = 10ms No voltage reappplied
	373		t = 8.3ms
	300		t = 10ms 100% $V_{RRM}$ reappplied
	314		t = 8.3ms
$I^2t$ Maximum $I^2t$ for fusing	636	A <sup>2</sup> s	t = 10ms No voltage reappplied
	580		t = 8.3ms
	450		t = 10ms 100% $V_{RRM}$ reappplied
	410		t = 8.3ms
$I^2\sqrt{t}$ Maximum $I^2\sqrt{t}$ for fusing	6360	A <sup>2</sup> √s	t = 0.1 to 10ms, no voltage reappplied
$V_{F(TO)1}$ Low level value of threshold voltage	0.80	V	$(16.7\% \times \pi \times I_{F(AV)} < I < \pi \times I_{F(AV)})$ , $T_J = T_J$ max.
$V_{F(TO)2}$ High level value of threshold voltage	0.90		$(I > \pi \times I_{F(AV)})$ , $T_J = T_J$ max.
$r_{f1}$ Low level value of forward slope resistance	6.80	mΩ	$(16.7\% \times \pi \times I_{F(AV)} < I < \pi \times I_{F(AV)})$ , $T_J = T_J$ max.
$r_{f2}$ High level value of forward slope resistance	5.70		$(I > \pi \times I_{F(AV)})$ , $T_J = T_J$ max.
$V_{FM}$ Max. forward voltage drop	1.30	V	$I_{pk} = 78\text{A}$ , $T_J = 25^\circ\text{C}$ , $t_p = 10\text{ms}$ sinusoidal wave

(2) Available only for Avalanche version, all other parameters the same as 25F.

## Thermal and Mechanical Specifications

Parameter	25F(R)	Units	Conditions
$T_J$ Max. junction operating temperature range	-65 to 175	°C	
$T_{stg}$ Max. storage temperature range	-65 to 200		
$R_{thJC}$ Max. thermal resistance, junction to case	1.5	K/W	DC operation
$R_{thCS}$ Max. thermal resistance, case to heatsink	0.5		Mounting surface, smooth, flat and greased
T Mounting torque, $\pm 10\%$	1.2 (1.5)	Nm	Lubricated threads (Not lubricated threads)
wt Approximate weight	7 (0.25)	g (oz)	
Case style	DO-203AA (DO-4)		See Outline Table

 $\Delta R_{thJC}$  Conduction

(The following table shows the increment of thermal resistance  $R_{thJC}$  when devices operate at different conduction angles than DC)

Conduction angle	Sinusoidal conduction	Rectangular conduction	Units	Conditions
180°	0.28	0.24	K/W	$T_J = T_{J \text{ max.}}$
120°	0.39	0.41		
90°	0.50	0.54		
60°	0.73	0.75		
30°	1.20	1.21		

## Ordering Information Table

Device Code	
<b>1</b> - A = Avalanche diode None = Standard diode	
<b>2</b> - Current rating: Code = $I_{F(AV)}$	
<b>3</b> - F = Standard device	
<b>4</b> - None = Stud Normal Polarity (Cathode to Stud) R = Stud Reverse Polarity (Anode to Stud)	
<b>5</b> - Voltage code: Code x 10 = $V_{RRM}$ (See Voltage Ratings table)	
<b>6</b> - None = Stud base DO-203AA (DO-4) 10-32UNF-2A M = Stud base DO-203AA (DO-4) M5 X 0.8 - (Not available for Avalanche diodes)	

Outlines Table

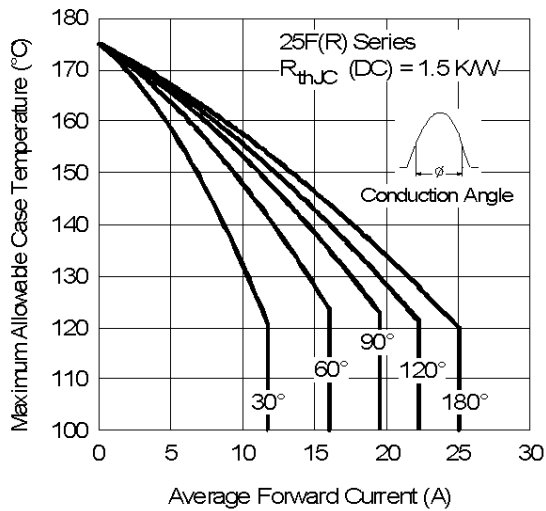
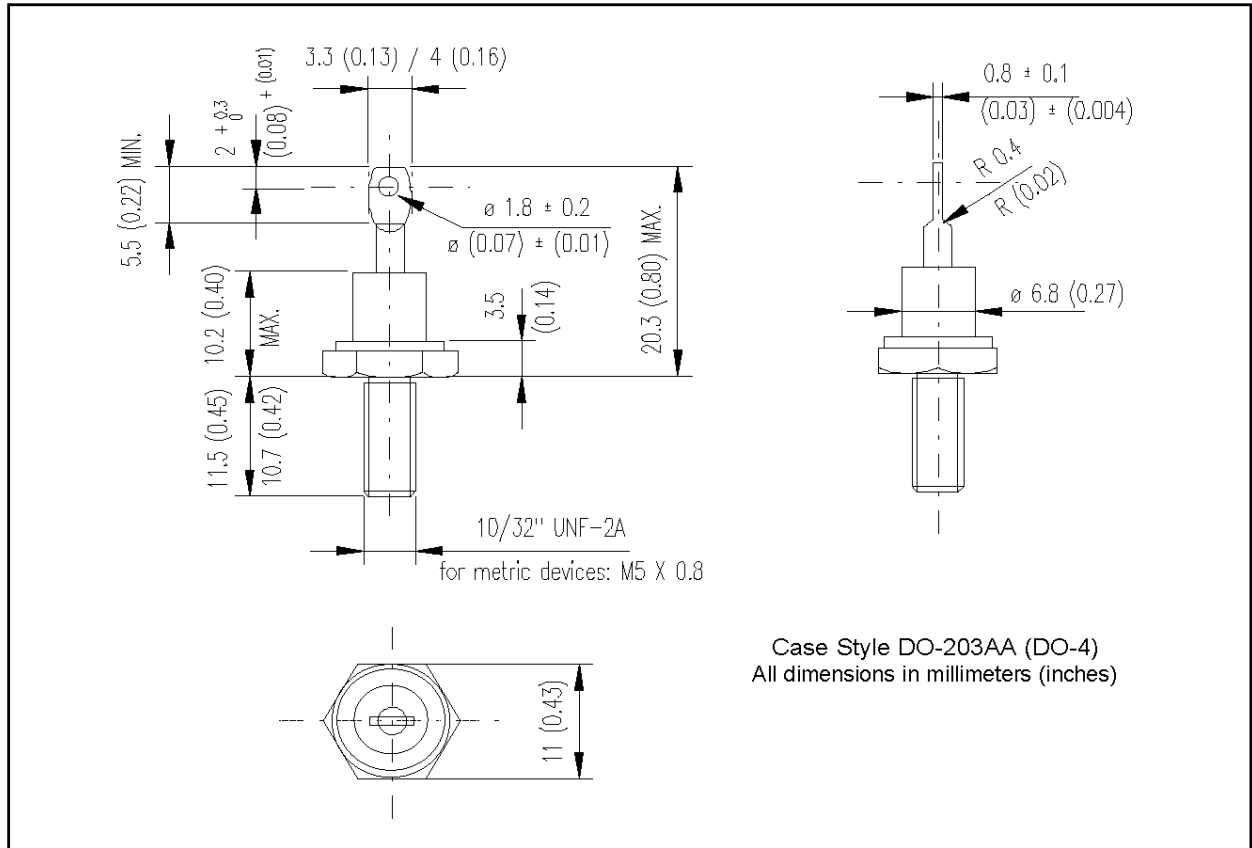

Fig. 1 - Current Ratings Characteristics

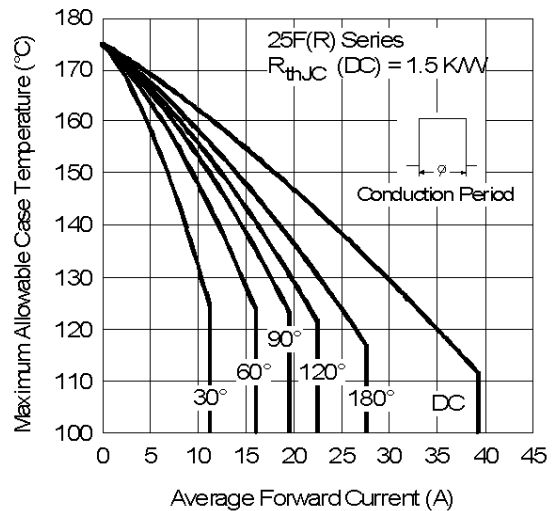

Fig. 2 - Current Ratings Characteristics

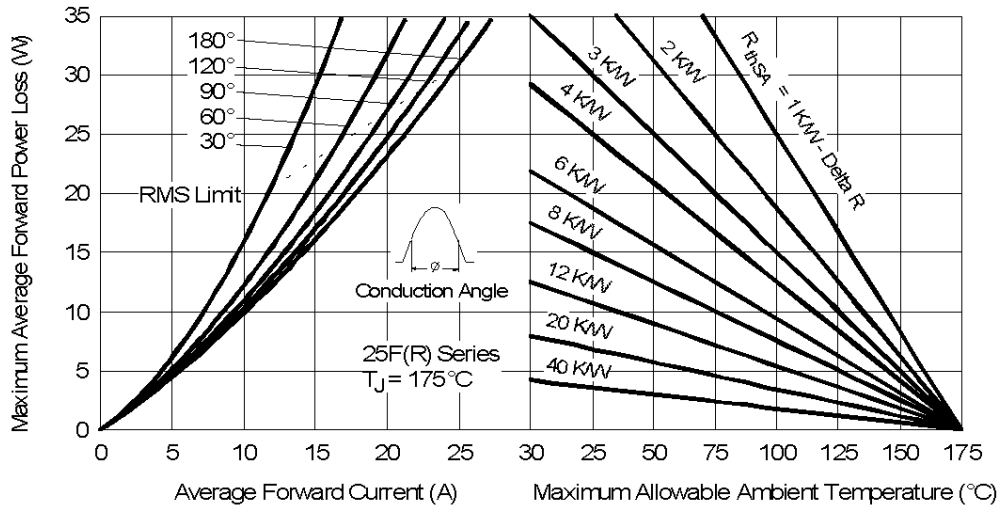

Fig. 3 - Forward Power Loss Characteristics

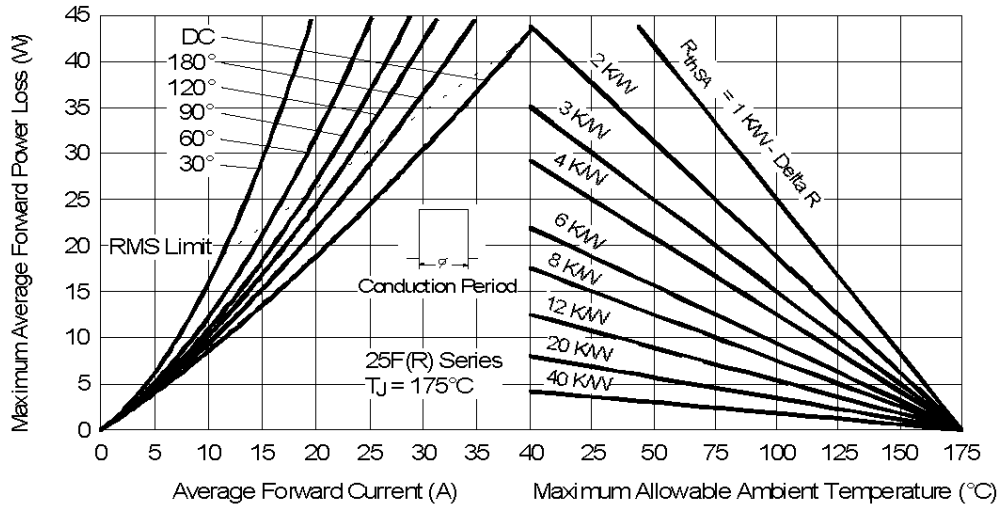

Fig. 4 - Forward Power Loss Characteristics

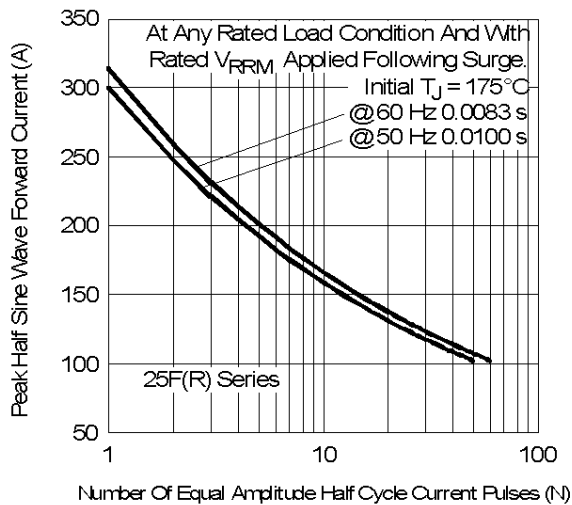

Fig. 5 - Maximum Non-Repetitive Surge Current

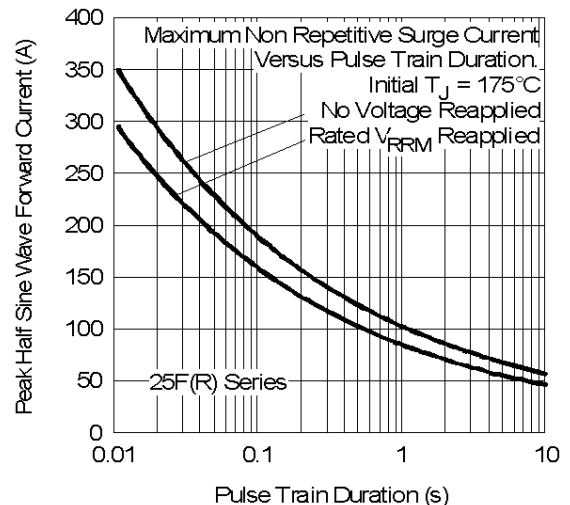

Fig. 6 - Maximum Non-Repetitive Surge Current

25F(R) Series

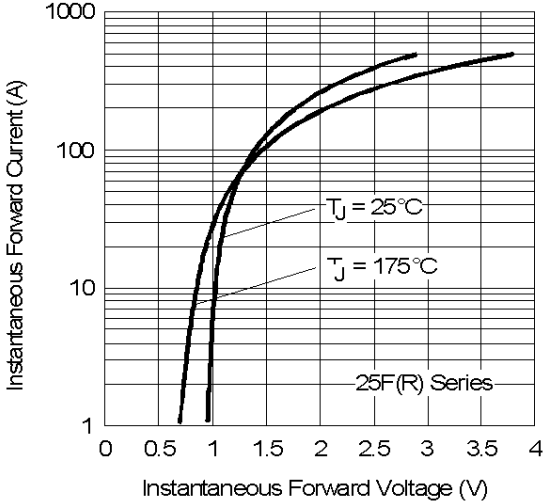

Fig. 7 - Forward Voltage Drop Characteristics

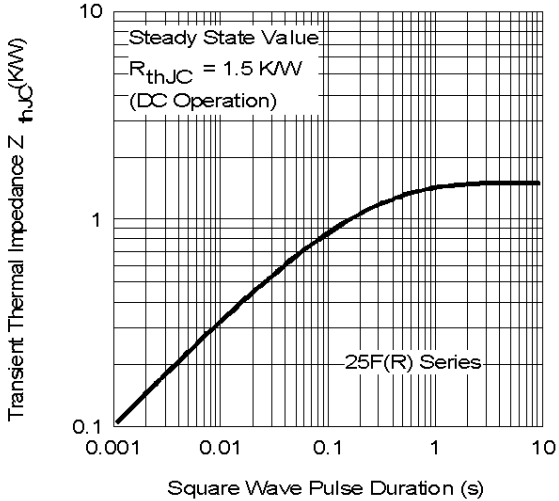

Fig. 8 - Thermal Impedance  $Z_{thJC}$  Characteristics